

## Tank - 8000 Gallon (36000litre)

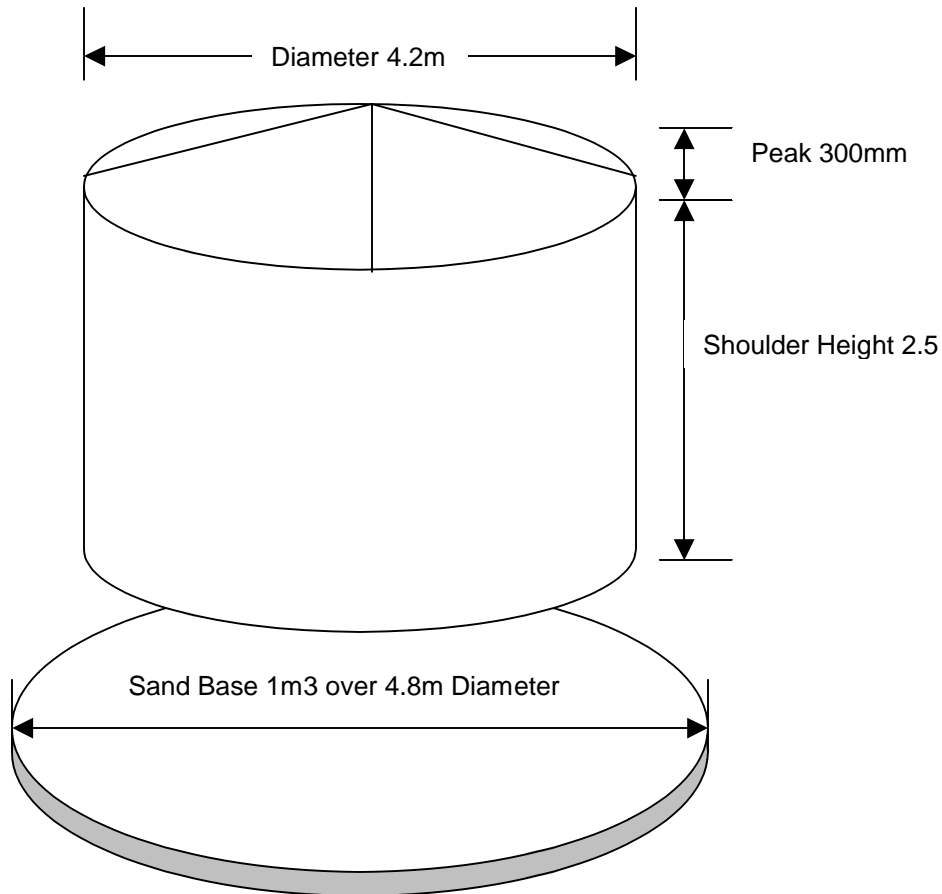

Volume: 8000 Gallon/36000 Litre

Diameter: 4.2m

Shoulder Height: 2.5m

Total Height: 2.8m

Sand Base: 1m<sup>3</sup> (Trailer Load) Spread over 4.8m Diameter to depth of 50-75mm.